



VAN PARTITIONS

Our safety partitions protect the most important asset: you



SAFE

Designed for maximum impact resistance. Proven by impact testing.



EFFICIENT

1. Contoured to maintain seat travel and ensure driver comfort.
2. Contoured to capitalize on cargo area floor space.



QUIET

Thickness of material cancels vibrations.

VAN PARTITIONS

APPLICATION GUIDE P. 32

CONTOURED

CLEARSHIELD P. 35
 COMPOSITE PARTITION P. 35
 COMPOSITE WITH WINDOW P. 37
 CONTOURED FULL PARTITION P. 42
 CONTOURED WITH WINDOW P. 38
 CONTOURED WITH PERFORATED WINDOW P. 40
 CONTOURED WIRE MESH P. 45
 MAX VIEW P. 34

STRAIGHT

STRAIGHT MID POSITION P. 51
 STRAIGHT WITH PERFORATED WINDOW, NO ACCESS P. 46
 STRAIGHT WITH PERFORATED WINDOW, SWING DOOR P. 48
 STRAIGHT WITH WINDOW, SLIDING DOOR P. 50

WALK THROUGH

STRAIGHT WALK THROUGH PARTITION P. 52

ACCESSORIES P. 51

Ranger Design safety partitions provide a solid and secure barrier between the occupants of the van and the cargo.

Built from heavy gauge steel, aluminum or thermoformed ABS and polycarbonate, these partitions are designed for maximum impact resistance and uphold a standard of safety set only by Ranger Design products.

Ranger Design partitions also provide a more comfortable environment for the driver by giving more seat travel and by not rattling as the vehicle drives down the road.

Application Guide



Type	Material	Chevrolet Express Standard Roof	Ford Transit Low Roof	Ford Transit Medium Roof	Ford Transit High Roof	Ford Transit Connect Standard Roof	GMC Savana Standard Roof
Clearshield	Composite	-	-	-	-	3520-M P. 35	-
Contoured composite safety partition	Composite	-	-	3310-FTM P. 36	3310-FTH P. 35	-	-
Contoured composite safety partition with window	Composite	-	-	3320-FTM P. 37	3320-FTH P. 37	-	-
Contoured full safety partition	Aluminum	3010-GS P. 43	3010-FTL P. 42	3010-FTM P. 42	3010-FTH P. 42	3010-TC P. 44	3010-GS P. 43
Contoured full safety partition	Steel	C12-H P. 44	C12-FTL P. 44	-	-	C12-E P. 44	C12-H P. 44
Contoured safety partition with perforated window	Steel	C10-H P. 41	C10-FTL P. 40	-	-	C10-E P. 40	C10-H P. 41
Contoured safety partition with window	Aluminum	3020-GS P. 39	3020-FTL P. 38	3020-FTM P. 38	3020-FTH P. 38	3020-TC P. 40	3020-GS P. 39
Contoured wire mesh partition	Steel	-	-	-	-	C13-E P. 45	-
Max View contoured safety partition	Composite	-	3320-FTL P. 34	-	-	3320-TC P. 34	-
Straight mid position safety partition	Aluminum	-	-	-	-	-	-
Straight mid position safety partition with window	Aluminum	-	-	-	-	-	-
Straight partition with perforated window, no access	Steel	C20-GS P. 47	C20-FTL P. 46	C20-FTM P. 47	C20-FTH P. 46	-	C20-GS P. 47
Straight partition with perforated window, swing door	Steel	C30-GS P. 49	C30-FTL P. 48	C30-FTM P. 48	C30-FTH P. 48	-	C30-GS P. 49
Straight partition with window, sliding door	Aluminum	-	-	3068-FTM P. 50	3068-FTH P. 50	-	-
Walk through straight partition	Aluminum	-	-	-	-	-	-
Walk through straight partition	Steel	C24-GS P. 53	C24-FTL P. 52	C24-FTM P. 52	C24-FTH P. 52	-	C24-GS P. 53

VAN PARTITIONS



Mercedes-Benz Metris Standard Roof	Mercedes-Benz Sprinter Low Roof	Mercedes-Benz Sprinter High Roof	Nissan NV Low Roof	Nissan NV High Roof	Nissan NV200 Standard Roof	Ram ProMaster Standard Roof	Ram ProMaster High Roof	Ram ProMaster City Standard Roof
3520-M P. 35	-	-	-	-	3520-M P. 35	-	-	3520-M P. 35
-	3310-DL P. 35	3310-DH P. 35	-	3310-NH P. 36	-	3310-RP P. 36	3310-RP P. 36	3310-PC P. 36
-	3320-DL P. 37	3320-DH P. 37	-	3320-NH P. 37	-	3320-RP P. 37	3320-RP P. 37	-
-	3010-DL P. 42	3010-DH P. 42	3010-NL P. 43	3010-NH P. 43	3010-NS P. 43	3010-RP P. 43	3010-RP P. 43	3010-PC P. 43
-	-	-	-	-	C12-W P. 44	-	-	C12-PC P. 44
C10-MM P. 41	-	-	-	-	C10-W P. 41	-	-	C10-PC P. 41
-	3020-DL P. 38	3020-DH P. 38	3020-NL P. 39	3020-NH P. 39	3020-NS P. 39	3020-RP P. 40	3020-RP P. 40	3020-PC P. 40
C13-MM P. 45	-	-	-	-	C13-W P. 45	-	-	C13-PC P. 45
3320-MM P. 34	-	-	-	-	-	-	-	3320-PC P. 34
-	-	3015-DH P. 51	-	-	-	-	-	-
-	-	3025-DH P. 51	-	-	-	-	-	-
-	C20-DL P. 46	C20-DH P. 46	C20-NL P. 47	C20-NH P. 47	-	C20-X P. 47	C20-X P. 47	-
-	C30-DL P. 48	C30-DH P. 48	C30-NL P. 49	C30-NH P. 49	-	C30-X P. 49	C30-X P. 49	-
-	3068-DL P. 50	3068-DH P. 50	-	-	-	3068-RP P. 50	3068-RP P. 50	-
-	-	-	-	-	-	-	-	-
-	C24-DL P. 52	C24-DH P. 52	C24-NL P. 53	C24-NH P. 53	-	C24-X P. 53	C24-X P. 53	-

VAN PARTITIONS

VAN PARTITIONS – CONTOURED

CONTOURED

CONTOURED MAX VIEW



3320-FTL

Ford Transit
Max View contoured safety partition

Composite	
	Low Roof
	50 lbs
	1.5 hr
	Yes
	8"



3320-MM

Mercedes-Benz Metris
Max View contoured safety partition

Composite	
	Standard Roof
	48 lbs
	1.2 hrs
	Yes
	9"



3320-PC

Ram ProMaster City
Max view contoured safety partition

Composite	
	Standard Roof
	42 lbs
	1 hr
	Yes
	7.1"



3320-TC

Ford Transit Connect
Max View contoured safety partition

Composite	
	Standard Roof
	36 lbs
	1 hr
	Yes
	8.4"

CONTOURED CLEARSHIELD



3520-M

All Standard Minivans
Clear germ barrier partition for minivans

Composite

Standard Minivans
10 lbs
0.25 hr
No
-

CONTOURED COMPOSITE



3310-DH

Mercedes-Benz Sprinter
Composite contoured safety partition

Composite

High Roof
70 lbs
1 hr
Yes
9"



3310-DL

Mercedes-Benz Sprinter
Composite contoured safety partition

Composite

Low Roof
65 lbs
1 hr
Yes
9"



3310-FTH

Ford Transit
Composite contoured safety partition

Composite

High Roof
66 lbs
1 hr
Yes
9"

VAN PARTITIONS – CONTOURED

VAN PARTITIONS



3310-FTM

Ford Transit

Composite contoured safety partition

Composite

Medium Roof

63 lbs

1 hr

Yes

9"



3310-NH

Nissan NV

Composite contoured safety partition

Composite

High Roof

63 lbs

1 hr

Yes

9"



3310-PC

Ram ProMaster City

Contoured safety partition

Composite

Standard Roof

44 lbs

1 hr

No

7.1"



3310-RP

Ram ProMaster

Composite contoured safety partition

Composite

Standard/High Roof

64 lbs

1 hr

Yes

9"





3320-DH

Mercedes-Benz Sprinter

Composite contoured safety partition with window

Composite

High Roof

71 lbs

1 hr

No

9"



3320-DL

Mercedes-Benz Sprinter

Composite contoured safety partition with window

Composite

Low Roof

67 lbs

1 hr

No

9"



3320-FTH

Ford Transit

Composite contoured safety partition with window

Composite

High Roof

68 lbs

1 hr

No

9"



3320-FTM

Ford Transit

Composite contoured safety partition with window

Composite

Medium Roof

65 lbs

1 hr

No

9"



3320-NH

Nissan NV

Composite contoured safety partition with window

Composite

High Roof

69 lbs

1 hr

No

9"



3320-RP

RAM ProMaster

Composite contoured safety partition with window

Composite

Standard/High Roof

68 lbs

1 hr

No

9"

LEGEND

Roof Height Set Back from B Pillar Weight Estimated Install Time Quickship

VAN PARTITIONS – CONTOURED

CONTOURED WITH WINDOW



3020-DH

Mercedes-Benz Sprinter
Contoured safety partition with window

Aluminum	
High Roof	
66 lbs	
1.2 hrs	
No	
5.5"	



3020-DL

Mercedes-Benz Sprinter
Contoured safety partition with window

Aluminum	
Low Roof	
64 lbs	
1.2 hrs	
No	
5.5"	



3020-FTH

Ford Transit
Contoured safety partition with window

Aluminum	
High Roof	
66 lbs	
1 hr	
Yes	
8.32"	



3020-FTL

Ford Transit
Contoured safety partition with window

Aluminum	
Low Roof	
48 lbs	
1 hr	
Yes	
7.16"	



3020-FTM

Ford Transit
Contoured safety partition with window

Aluminum	
Medium Roof	
52 lbs	
1 hr	
Yes	
8.32"	



SETBACK FROM B PILLAR

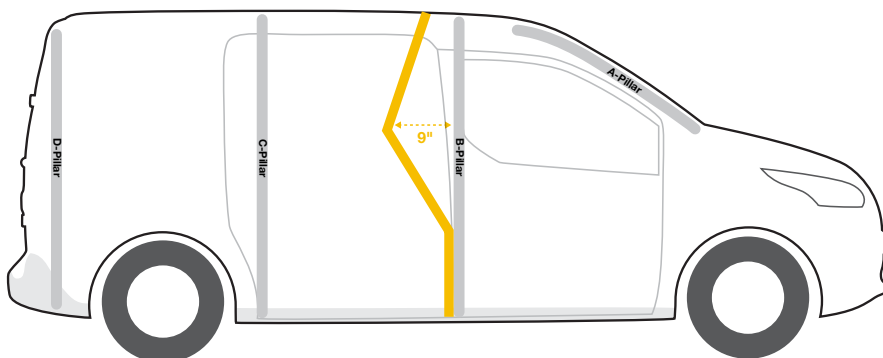

3020-GS

Chevrolet Express, GMC Savana
Contoured safety partition with window

Aluminum

Standard Roof
49 lbs
1 hr
No
5.56"



3020-NH

Nissan NV
Contoured safety partition with window

Aluminum

High Roof
59 lbs
1.2 hrs
No
5.78"



3020-NL

Nissan NV
Contoured safety partition with window

Aluminum

Low Roof
42 lbs
1 hr
No
5.78"



3020-NS

Nissan NV200
Contoured safety partition with window

Aluminum

Standard Roof
33 lbs
1 hr
Yes
3.5"

LEGEND

Roof Height Set Back from B Pillar Weight Estimated Install Time Quickship

VAN PARTITIONS – CONTOURED

VAN PARTITIONS



3020-PC

Ram ProMaster City
Contoured safety partition with window

Aluminum

Standard Roof

41 lbs

1 hr

Yes

8.1"



3020-RP

Ram ProMaster
Contoured safety partition with window

Aluminum

Standard / High Roof

59 lbs

1 hr

Yes

6.07"

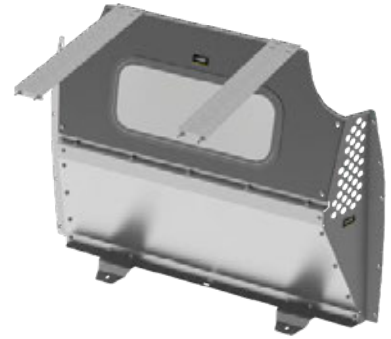

3020-TC

Ford Transit Connect
Contoured safety partition with window

Aluminum

Standard Roof

42 lbs

1 hr

Yes

10.75"

CONTOURED WITH PERFORATED WINDOW



C10-E

Ford Transit Connect
Contoured safety partition
with perforated window

Steel

Standard Roof

53 lbs

1 hr

Yes

10.5"



C10-FTL

Ford Transit
Contoured safety partition
with perforated window

Steel

Low Roof

66 lbs

1 hr

Yes

7.11"

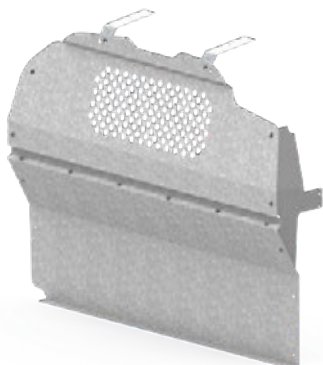

C10-H

Chevrolet Express, GMC Savana
Contoured safety partition with perforated window

Steel

Standard Roof

58 lbs

1 hr

Yes

5.56"



C10-MM

Mercedes-Benz Metris
Contoured safety partition with perforated window

Steel

Standard Roof

62 lbs

1 hr

Yes

11"

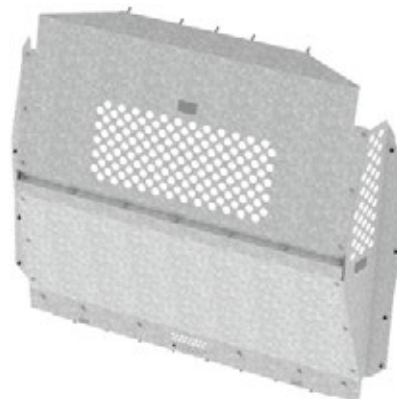

C10-PC

Ram ProMaster City
Contoured safety partition with perforated window

Steel

Standard Roof

63.3 lbs

1 hr

Yes

8.05"

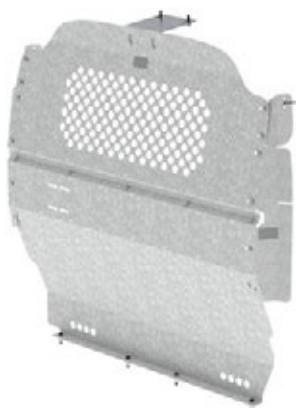

C10-W

Nissan NV200
Contoured safety partition with perforated window

Steel

Standard Roof

42 lbs

1 hr

Yes

3.5"



LEGEND

Roof Height

Set Back from B Pillar

Weight

Estimated Install Time

Quickship

VAN PARTITIONS – CONTOURED

CONTOURED FULL PARTITION

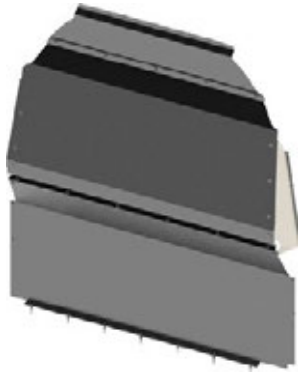

3010-DH

Mercedes-Benz Sprinter
Contoured safety partition

Aluminum

High Roof

59 lbs

1.2 hrs

Yes

5.5"

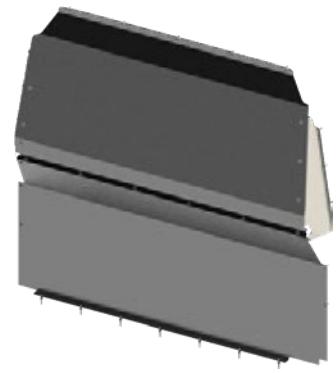

3010-DL

Mercedes-Benz Sprinter
Contoured safety partition

Aluminum

Low Roof

57 lbs

1.2 hrs

No

5.5"



3010-FTH

Ford Transit
Contoured safety partition

Aluminum

High Roof

57 lbs

1 hr

Yes

8.32"



3010-FTL

Ford Transit
Contoured safety partition

Aluminum

Low Roof

46 lbs

1 hr

Yes

7.16"



3010-FTM

Ford Transit
Contoured safety partition

Aluminum

Medium Roof

52 lbs

1 hr

Yes

8.32"



3010-GS

Chevrolet Express, GMC Savana
Contoured safety partition

Aluminum

Standard Roof

47 lbs

1 hr

Yes

5.56"



3010-NH

Nissan NV
Contoured safety partition

Aluminum

High Roof

64.1 lbs

1.2 hrs

Yes

5.78"



3010-NL

Nissan NV
Contoured safety partition

Aluminum

Low Roof

42 lbs

1 hr

Yes

5.78"



3010-NS

Nissan NV200
Contoured safety partition

Aluminum

Standard Roof

42 lbs

1 hr

Yes

3.3"



3010-PC

Ram ProMaster City
Contoured safety partition

Aluminum

Standard Roof

39 lbs

1 hr

Yes

8.1"



3010-RP

Ram ProMaster
Contoured safety partition

Aluminum

Standard / High Roof

62.8 lbs

1 hr

Yes

6.07"

LEGEND



Roof Height



Set Back from B Pillar



Weight



Estimated Install Time



Quickship

VAN PARTITIONS – CONTOURED



3010-TC

Ford Transit Connect
Contoured safety partition

Aluminum

Standard Roof

39.75 lbs

1 hr

Yes

10.75"

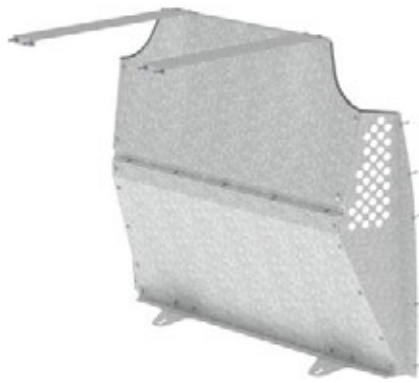

C12-E

Ford Transit Connect
Contoured safety partition

Steel

Standard Roof

55 lbs

1 hr

Yes

10.5"



C12-FTL

Ford Transit
Contoured safety partition

Steel

Low Roof

64 lbs

1 hr

Yes

7.11"

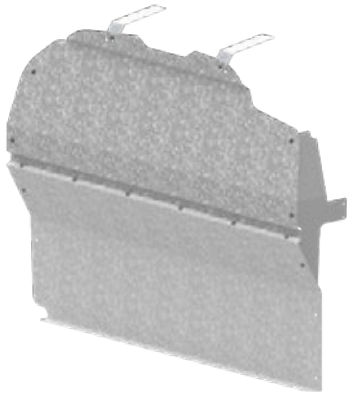

C12-H

Chevrolet Express, GMC Savana
Contoured safety partition

Steel

Standard Roof

53 lbs

1 hr

No

5.56"

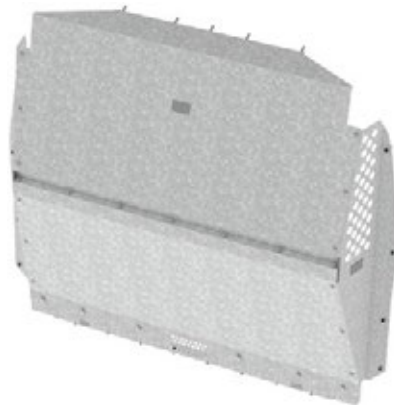

C12-PC

Ram ProMaster City
Contoured safety partition

Steel

Standard Roof

86 lbs

1 hr

Yes

8.05"



C12-W

Nissan NV200
Contoured safety partition

Steel

Standard Roof

53 lbs

1 hr

Yes

2.94"

CONTOURED WIRE MESH

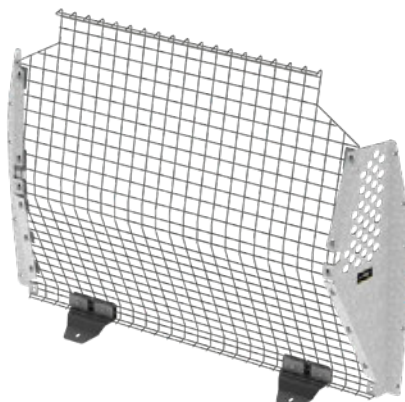

C13-E
Ford Transit Connect
Contoured wire mesh partition

Steel

Standard Roof
37 lbs
0.7 hr
Yes
10.5"

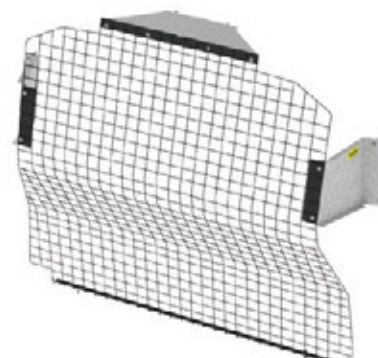

C13-MM
Mercedes-Benz Metris
Contoured wire mesh partition

Steel

Standard Roof
37 lbs
1.2 hrs
Yes
11"



C13-PC
Ram ProMaster City
Contoured wire mesh partition

Steel

Standard Roof
72 lbs
1 hr
Yes
8.33"

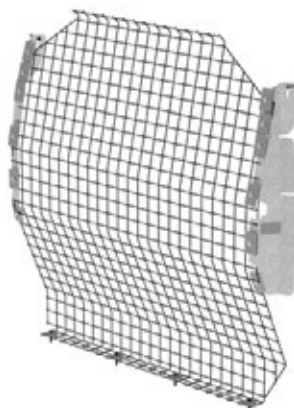

C13-W
Nissan NV200
Contoured wire mesh partition

Steel

Standard Roof
31.4 lbs
0.7 hr
Yes
3.45"



VAN PARTITIONS – STRAIGHT

STRAIGHT

STRAIGHT WITH PERFORATED WINDOW — NO ACCESS

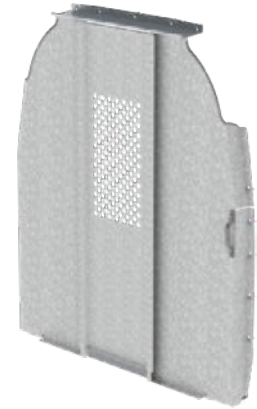

C20-DH

Mercedes-Benz Sprinter
Straight partition with perforated window, no access

Steel

High Roof

89 lbs

1 hr

Yes

7.5"

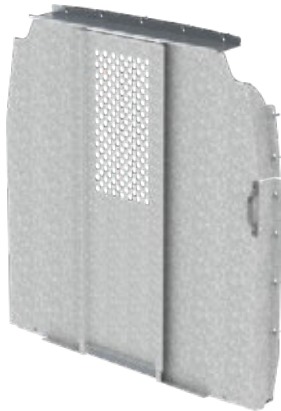

C20-DL

Mercedes-Benz Sprinter
Straight partition with perforated window, no access

Steel

Low Roof

80 lbs

1 hr

Yes

7.5"



C20-FTH

Ford Transit
Straight partition with perforated window, no access

Steel

High Roof

92.1 lbs

1 hr

Yes

4.76"



C20-FTL

Ford Transit
Straight partition with perforated window, no access

Steel

Low Roof

64 lbs

1 hr

Yes

4.25"



C20-FTM

Ford Transit

Straight partition with perforated window, no access

Steel

Medium Roof

77 lbs

1 hr

Yes

4.76"

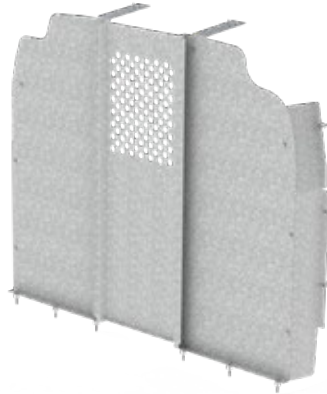

C20-GS

Chevrolet Express, GMC Savana

Straight partition with perforated window, no access

Steel

Standard Roof

61 lbs

1.5 hr

Yes

6.75"

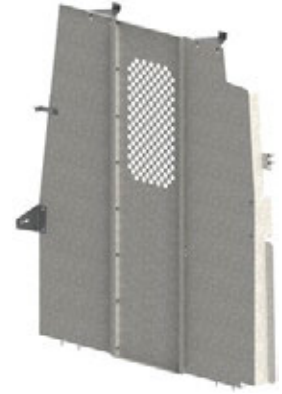

C20-NH

Nissan NV

Straight partition with perforated window, no access

Steel

High Roof

80 lbs

1.5 hrs

Yes

5.5"



C20-NL

Nissan NV

Straight partition with perforated window, no access

Steel

Low Roof

58 lbs

1 hr

Yes

5.5"

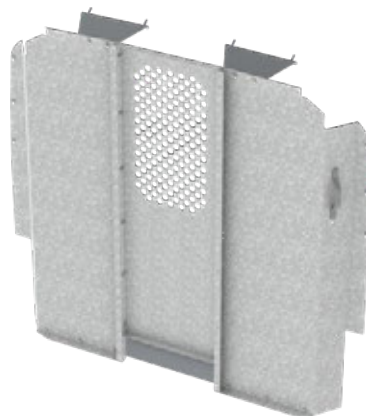

C20-X

Ram ProMaster

Straight partition with perforated window, no access

Steel

Standard / High Roof

78 lbs

1 hr

Yes

6.24"



VAN PARTITIONS – STRAIGHT

STRAIGHT WITH PERFORATED WINDOW — SWING DOOR



C30-DH

Mercedes-Benz Sprinter

Straight partition with perforated window, swing door

Steel

High Roof

92 lbs

1 hr

No

8"

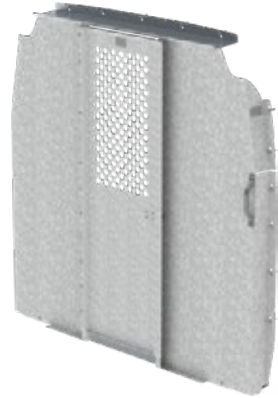

C30-DL

Mercedes-Benz Sprinter

Straight partition with perforated window, swing door

Steel

Low Roof

83 lbs

1 hr

No

8"



C30-FTH

Ford Transit

Straight partition with perforated window, swing door

Steel

High Roof

86 lbs

1.5 hrs

Yes

4.96"



C30-FTL

Ford Transit

Straight partition with perforated window, swing door

Steel

Low Roof

68 lbs

1.5 hrs

Yes

4.61"

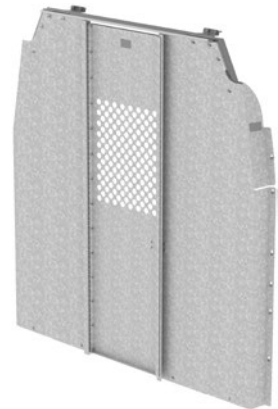

C30-FTM

Ford Transit

Straight partition with perforated window, swing door

Steel

Medium Roof

79 lbs

1.5 hrs

Yes

4.96"

VAN PARTITIONS – STRAIGHT

VAN PARTITIONS

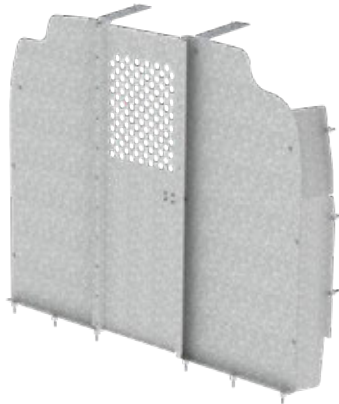

C30-GS

Chevrolet Express, GMC Savana

Straight partition with perforated window, swing door

Steel

Standard Roof

63.2 lbs

1 hr

Yes

6.75"

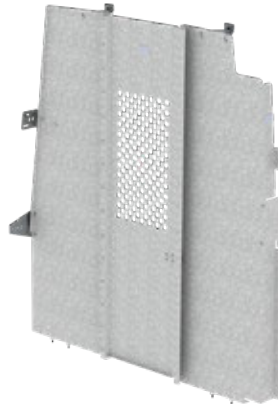

C30-NH

Nissan NV

Straight partition with perforated window, swing door

Steel

High Roof

82.5 lbs

1.2 hr

Yes

5.5"



C30-NL

Nissan NV

Straight partition with perforated window, swing door

Steel

Low Roof

60.5 lbs

1 hr

Yes

5.5"

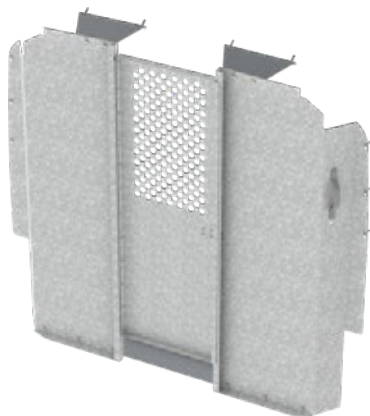

C30-X

Ram ProMaster

Straight partition with perforated window, swing door

Steel

Standard / High Roof

80 lbs

1 hr

Yes

6.24"



LEGEND

Roof Height

Set Back from B Pillar

Weight

Estimated Install Time

Quickship

VAN PARTITIONS – STRAIGHT

STRAIGHT WITH WINDOW — SLIDING DOOR



3068-DH

Mercedes-Benz Sprinter

Straight partition with window,
sliding door

Aluminum

High Roof

97.9 lbs

1.5 hrs

Yes

8"



3068-DL

Mercedes-Benz Sprinter

Straight partition with window,
sliding door

Aluminum

Low Roof

84 lbs

1.5 hrs

Yes

7.25"



3068-FTH

Ford Transit

Straight partition with window,
sliding door

Aluminum

High Roof

77 lbs

1.5 hrs

Yes

6.29"



3068-FTM

Ford Transit

Straight partition with window,
sliding door

Aluminum

Medium Roof

84.2 lbs

1.5 hrs

Yes

6.29"



3068-RP

Ram ProMaster

Straight partition with window,
sliding door

Aluminum

Standard / High Roof

76 lbs

1.5 hrs

Yes

6.26"

STRAIGHT MID POSITION



3015-DH

Mercedes-Benz Sprinter
Mid position straight safety partition

Aluminum

High Roof

59 lbs

1.2 hrs

No

2.5"



3025-DH

Mercedes-Benz Sprinter
Mid position straight safety partition with window

Aluminum

High Roof

66 lbs

1.2 hrs

No

2.5"

ACCESSORIES



3024

Universal
Partition window with frame for 3010

Aluminum

Universal

5 lbs

0.2 hr

No

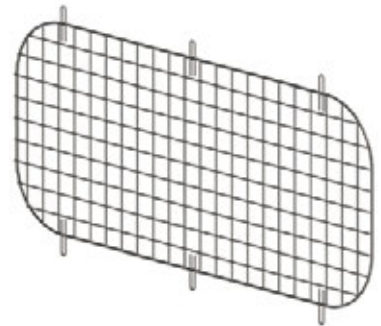

3044

Universal
Grill for partition window for 3020, 3025, 3068

Steel

Universal

2 lbs

0.5 hr

No

VAN PARTITIONS – WALK THROUGH

WALK THROUGH

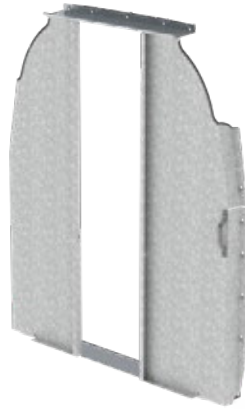

C24-DH
Mercedes-Benz Sprinter
Straight walk through partition

Steel	
High Roof	
66 lbs	
1 hr	
No	
7.5"	

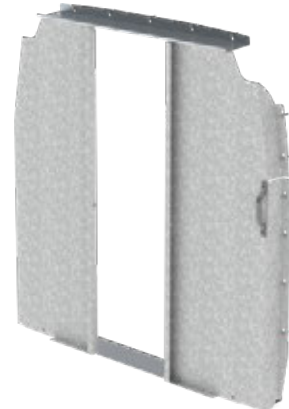

C24-DL
Mercedes-Benz Sprinter
Straight walk through partition

Steel	
Low Roof	
61 lbs	
1 hr	
No	
7.5"	

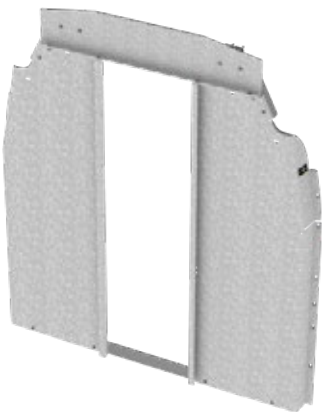

C24-FTH
Ford Transit
Straight walk through partition

Steel	
High Roof	
65 lbs	
1.2 hrs	
Yes	
4.76"	



C24-FTL
Ford Transit
Straight walk through partition

Steel	
Low Roof	
48 lbs	
1.2 hrs	
Yes	
4"	



C24-FTM
Ford Transit
Straight walk through partition

Steel	
Medium Roof	
58 lbs	
1.2 hrs	
Yes	
4.76"	



C24-GS

Chevrolet Express, GMC Savana
Straight walk through partition

Steel

Standard Roof

46.5 lbs

1 hr

Yes

6.75"



C24-NH

Nissan NV
Straight walk through partition

Steel

High Roof

57 lbs

1 hr

Yes

5.5"



C24-NL

Nissan NV
Straight walk through partition

Steel

Low Roof

43.5 lbs

1 hr

Yes

5.5"



C24-X

Ram ProMaster
Straight walk through partition

Steel

Standard / High Roof

70 lbs

1 hr

Yes

6.24"

